

## F-tone Network 10KM SFP+ ER Optical Receiver

- ◆ Support rate up to 10Gbps
- ◆ 10 Fiber connection
- ◆ Temperature  $\leq 70^\circ\text{C}$
- ◆ Low Power consumption
- ◆ Single power supply
- ◆ Diagnostic Performance Monitoring
- ◆ Forward OS protection
- ◆ Forward PR protection
- ◆ RoHS compliant
- ◆ Operating temperature:
  - Storage:  $0^\circ\text{C}$  to  $+70^\circ\text{C}$
  - Working:  $-40^\circ\text{C}$  to  $+85^\circ\text{C}$

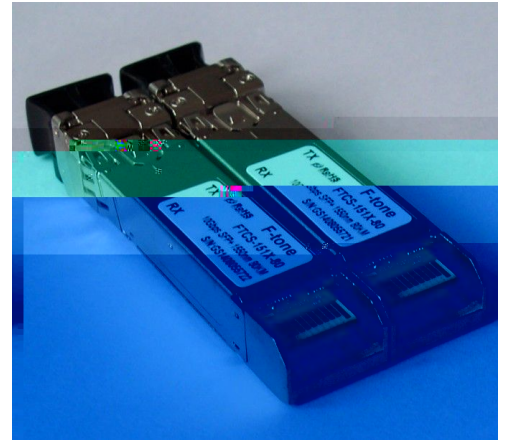

- ◆ Forward OS protection
- ◆ Forward PR protection
- ◆ 10 Fiber connection

F-tone Network SFP+ER Optical Receiver is available in 10km SE-ERE and 10 Fiber connection



e tr n cei er con i t o two ection : e tr n itter ection incorpor te co e EM er n  
 t e recei er ection con i t o P N p oto io e inte r te wit o e ti c er  
 et re ire ent F-tone Network SFP+ER i it i no tic nction re i e i -wire  
 eri inter ce peci ie in SFF- w ic ow re -ti e cce to e ice oper tin p r eter  
 c tr n cei er te per t re er i c rrent tr n itte optic power recei e optic power  
 n tr n cei er pp ot e

S pp ot e	cc	-0		
Stor e e per t re	t	- 0		e
Re ti e i it	R	0		

S pp ot e	cc				
S pp c rrent	cc		0	0	
Oper tin e te per t re	c	-	-	0	e
Mo e Power i ip tion	P	-			

S pp c rrent i re etween n R  
 n-r i e ine c rrent e e o e te t te c rrent re ire ent

enter e en t		0			n
Optic er e Power	Po	0	-	+	
Optic OM Power	Po	-			
Si e Mo e S ppre ion R tio	SMSR	0	-	-	
Optic r n it Power ( i e )	P _ S E	-	-	- 0	
E tinction R tio	ER			-	
R N OM				-	
Optic Ret rn o o er nce					

RN e re enti e wit ret rn o t

t R te	Mr	-	0		p
--------	----	---	---	--	---



np t i erenti i pe nce	Ri	-	00	-	Ω
i erenti t np t	t FF	0	-	0	
r n it i e ot e		0	-	cc +0	
r n itEn e ot e	en	0	-	+0	
r n it i e ert i e	n	-	-	00	

np t Oper tin e en t		0	-		n
er e recei e power		-	-	- 0	
Recei er en iti it in OM		-	-	-	
Stre e recei er en iti it in OM				-	
M i np tPower	R -o ero	-	-	-	
Re ect nce	Rr	N -	-	-	
o o Si n erte		-	-	-	
OS e- erte		-	-	-	
OS erte i		0	-	-	

Me re wit con or nce te t i n or ER 0- e tre e en iti it e int et e re or te e e ER e re ent w ic inc et e e ect o R circ it ti reco en e t t t e t0 ition r in e oc te i co ponent e e e re ent re e wit o t t e e ect o R circ it

t R te	Mr	-	0		p
i erenti O tp t Swin	o t P-P	0	-	0	
Ri e F i e	r		-	-	p
o o Si n - erte	O		-	cc +0 -	
o o Si n -Ne te	O	0	-	+0	

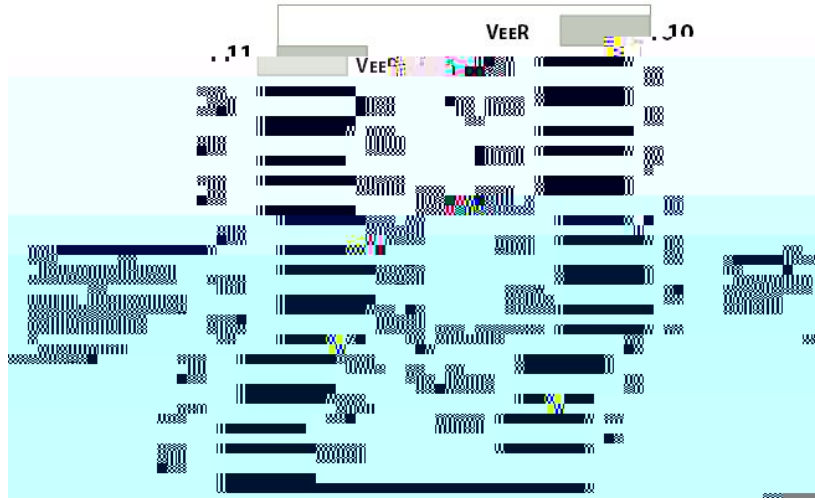

EE	rnitterron
_F	rnitterFt
_S	rnitteri e ero tp t i e on i or open
S	-wire Seri nter ce t ine
S	-wire Seri nter ce ock ine
MO _ S	Mo e ent ron e wit int e o e
RS0	RS0 or R te Se ect: Open or ow Mo e pport ≤ p i Mo e pport to 0
R _ OS	o o Si n in ic tion o ic 0 in ic te nor oper tion
RS	No connection re ire
0	ERR



	+	r n itter in o pe
	-	r n itter n erte in o pe
0	EE	r n itter ro n

Mo e circ it ro n i o te ro o ec i ro n wit inte o e  
 o e p e p wit k- 0k o on o t o r to o t e etween n  
 \_ i ei n in p t cont ct wit k toto 0k p p to cc in i ete o e  
 Mo \_ Si connecte to ee or ee R in te SFP+ o e e o t p t i cont ct p to cc \_ o t wit  
 re i to r in te r ne k to 0k Mo \_ Si erte "i w ente SFP+ o ei p ic ent ro o t  
 ot  
 RS0 n RS re o e in p t n r

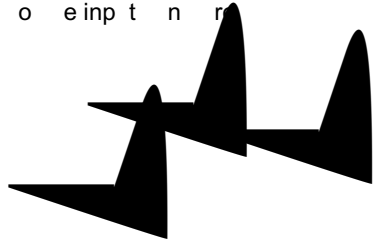

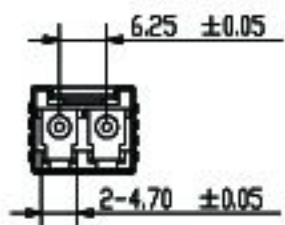
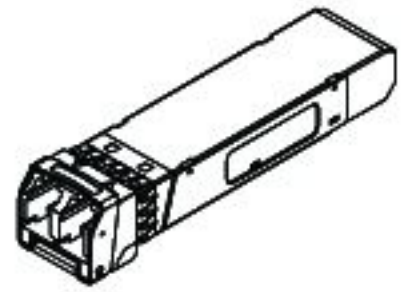
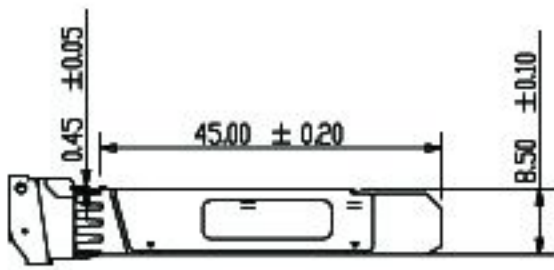
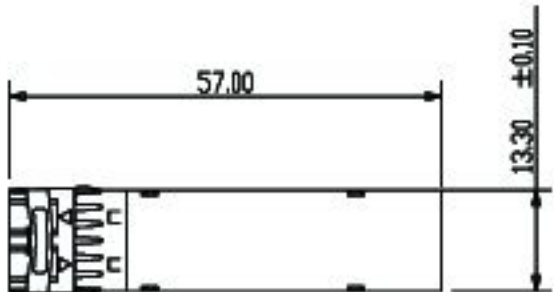
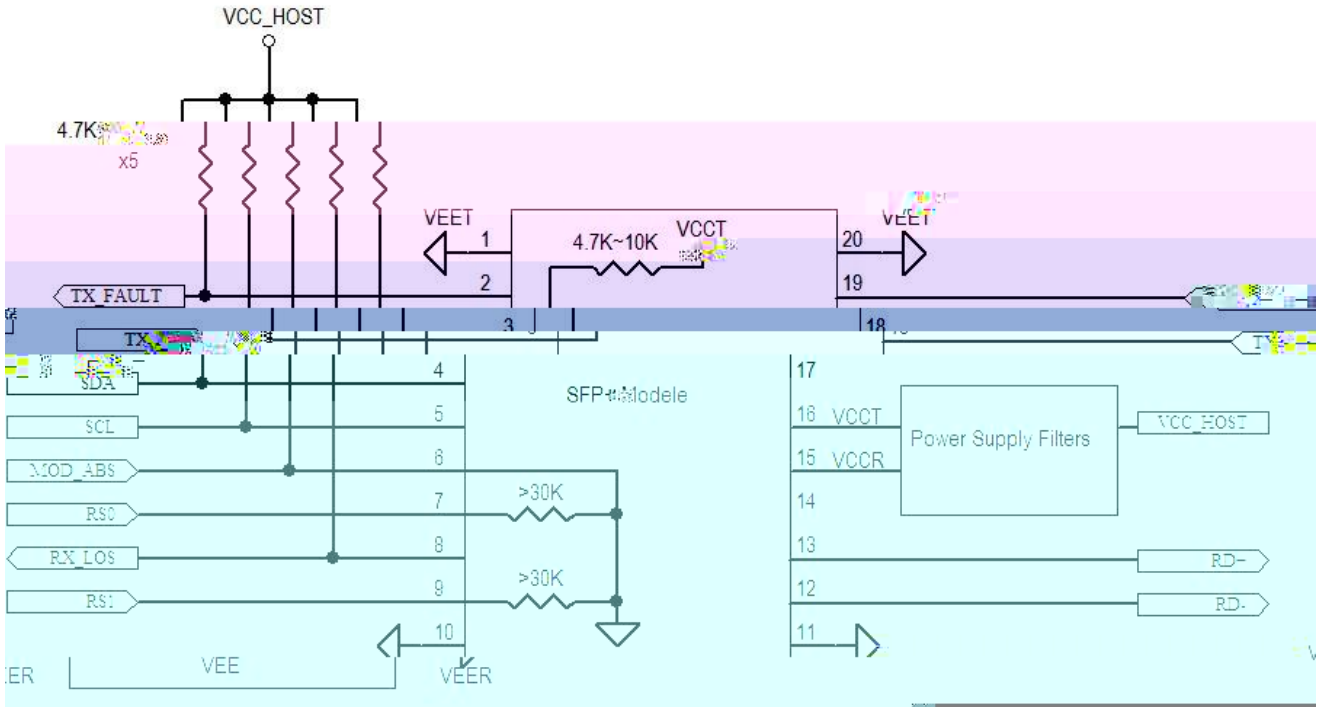



F-tone Networks

# 北亿纤通科技有限公司

集团旗下

---

F-tone Network SFP+ tr n cei eri e i ne to e 0 e er

